

\*There are seven total prox. holes, six on the hex sides, one on the end.

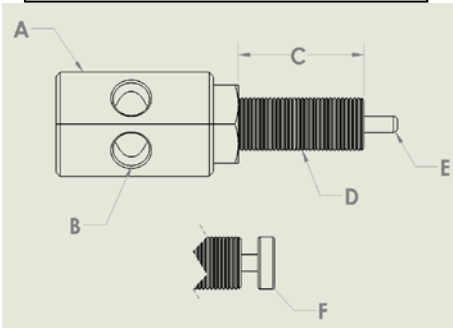

**STANDARD SPECIFICATIONS**

Model	5mm Unit	8mm Unit	12mm Unit
(A)BASE	5/8" Alum Hex	3/4" Alum Hex	1" Alum Hex
BASE LENGTH	1"	1 3/16"	1 7/16"
(B)THD PROX HOLE	5mm x 0.5	8mm x 1.0	12mm x 1.0
(C) BARREL LENGTH	1 1/2"	1 1/2"	2"
(D) THREAD	3/8"-24	3/8"-24	9/16"-18
(E) ACTUATOR LENGTH	3/8"	3/8"	3/8"
(F) FLAT NOSE TIP	.125 x .375 DIA	.125 x .375 DIA	.125 x .375 DIA